

VETRA

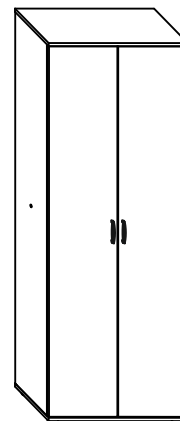

Montageanleitung / Notice de Montage / Assembling Instruction

ART. NR: 15 500 100
EAN: 40 10 340 15 51 06

ORDER : -----

DE: Wichtige Montage – Tipps hier zum herunterladen:

EN: Important assembling suggestions download:

FR: Conseils de montage importants à télécharger ici :

BG: Важни съвети за сглобяване, които да изтеглите от тук:

CZ: Důležité montážní typy ke stažení zde:

EE: Olulised kokkupanemisetpanekute allalaadimine:

DK: Vigtige montage tips til at downloade:

ES: Descarga de sugerencias de montaje importantes:

FI: Tärkeät kokoamisedotukset ladataan:

GR: Λήψη σημαντικών προτάσεων συναρμολόγησης:

HR: Preuzimanje važnih prijedloga za sastavljanje:

HU: Fontos összeszerelési javaslatok letöltése:

IT: Download importanti suggerimenti di montaggio:

LT: Svarbūs surinkimo pasiūlymai atsisiųsti:

LU: Wichtig Versammlungsvirschléi eroflueden:

LV: Svarīgu montāžas ieteikumu lejupielāde:

NL: Belangrijke montagesuggesties downloaden:

NO: Viktige nedlastingsforslag:

PL: Pobieranie ważnych sugestii montażowych:

PT: Download de sugestões importantes de montagem:

RO: Descărcare de sugestii importante de asamblare:

RS: Преузимање важних предлога за састављање:

RU: Важные предложения по сборке скачать:

SL: Prenos pomembnih predlogov za sestavljanje:

SE: Viktiga hämtningsförslag:

SK: Stiahnutie dôležitých návrhov na zostavenie:

TR: Önemli montaj önerileri indir:



















ARB: المهمة التجميع اقتراحات تنزيل:

 **Inter Link**®

Z. A. du Niederwald
F-67470 Seltz
www.interlink-sas.com



VETRA

①		12 x	⑰	 4x27	4 x
②		4 x	⑱		1 x
③		4 x			
④		4 x			
⑤		16 x			
⑥		1 x			
⑦		8 x			
⑧	 3x20	8 x			
⑨		4 x			
⑩		2 x			
⑪		2 x			
⑫	 1,2x25	10 x			
⑬		6 x			
⑭	 6,3x13	12 x			
⑮	 3,5x16	13 x			
⑯		2 x			

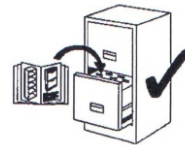
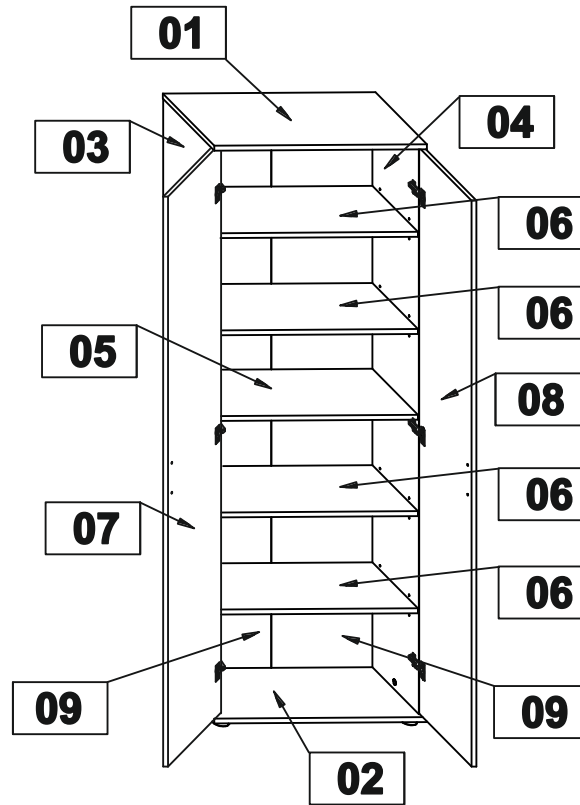

60 min.

2-12

Link's®

Inter Link SAS

Z. A. du Niederwald
F-67470 Seltz
Frankreich/France

International:

Téléfon: (0033) 3 88 05 55 50

Téléfax: (0033) 3 88 05 55 68

National:

Téléphone 03.88.05.55.59

Télécopie 03.88.05.55.79

e-mail:

service@interlink-sa.com

www.interlink-sa.com

VETRA

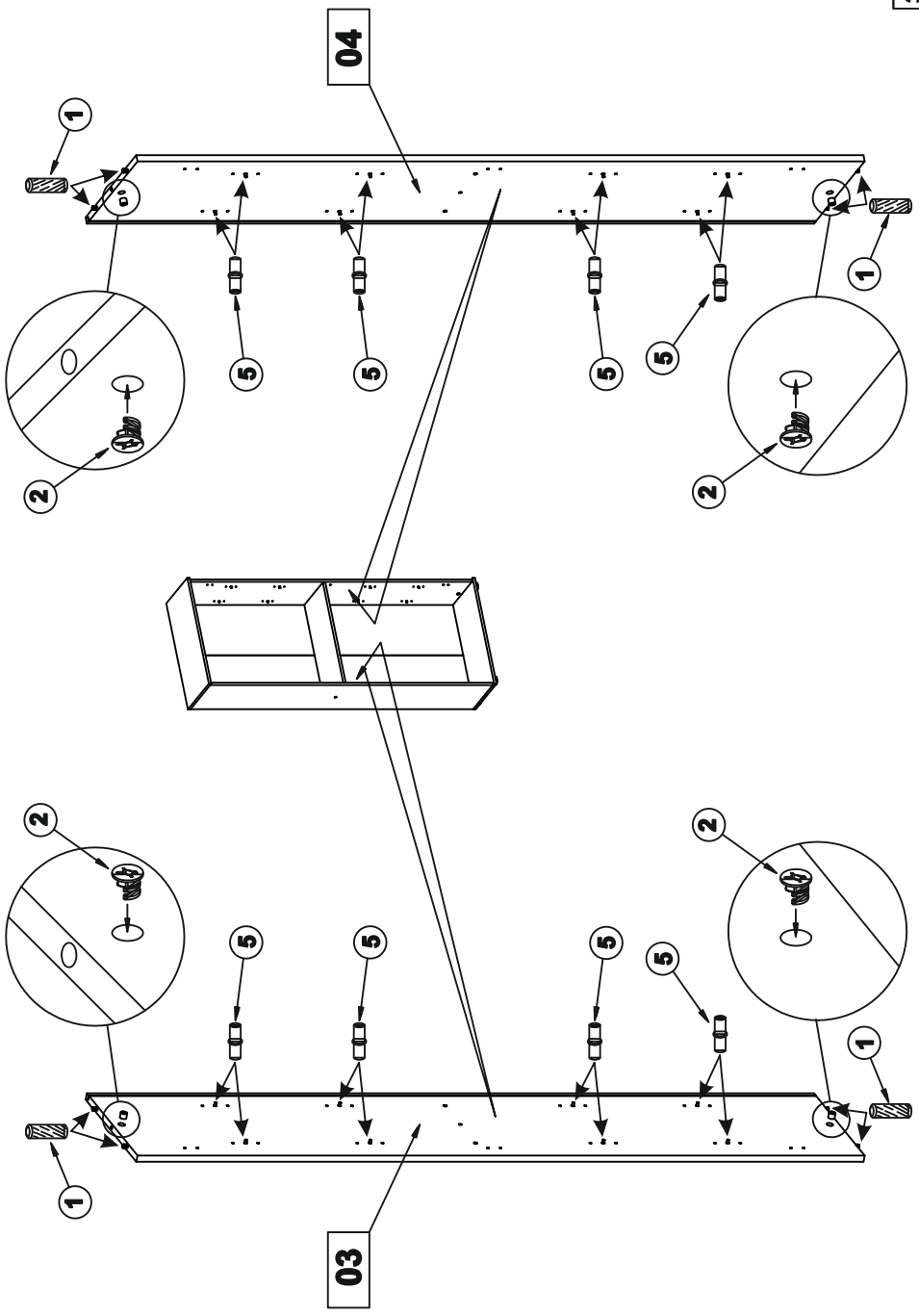

3-12

VETRA

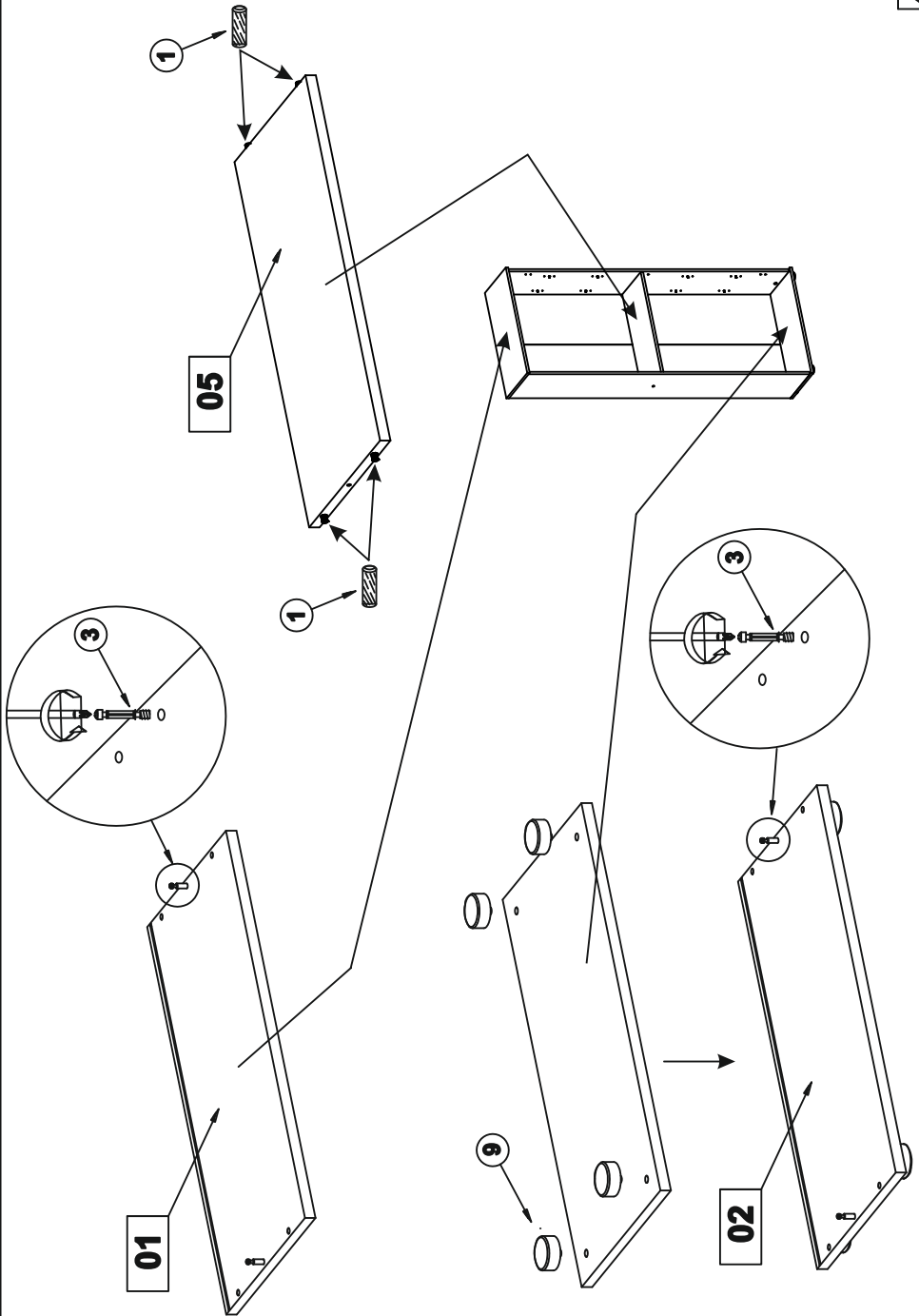

4-12

VETRA

5-12

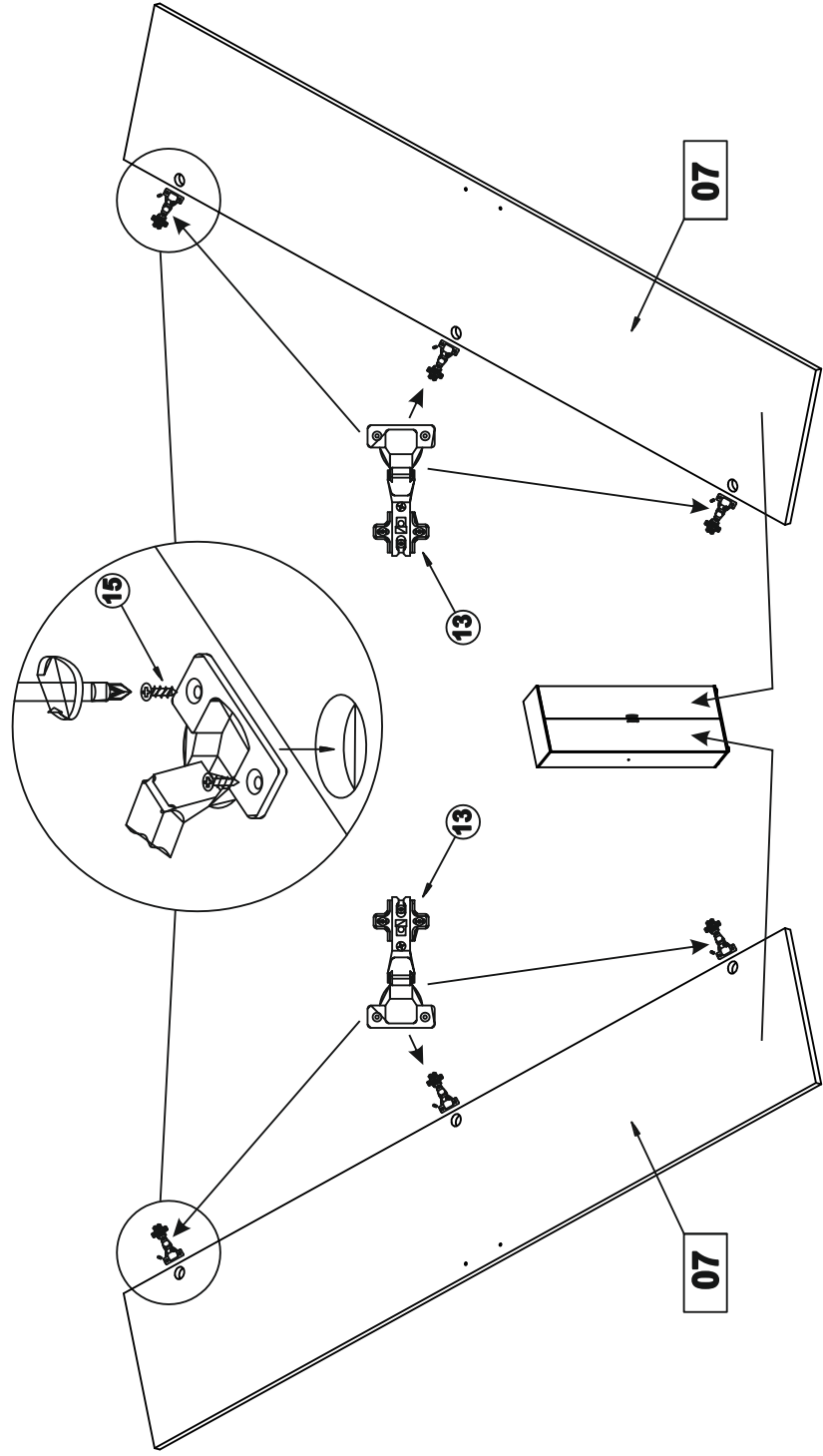

VETRA

6-12

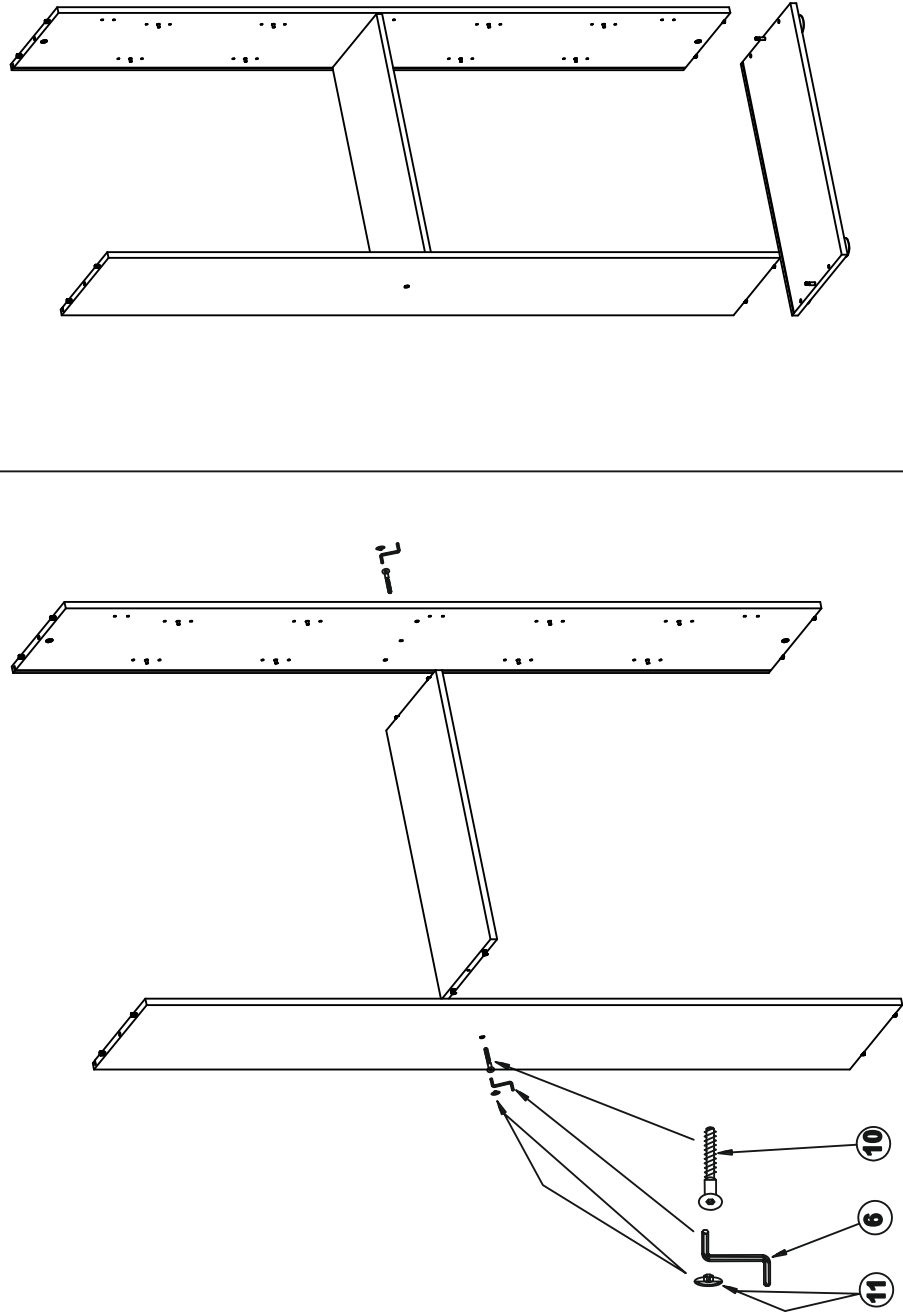

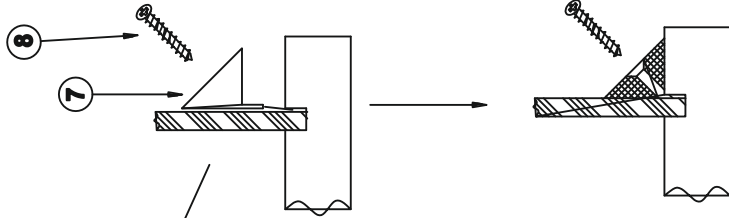
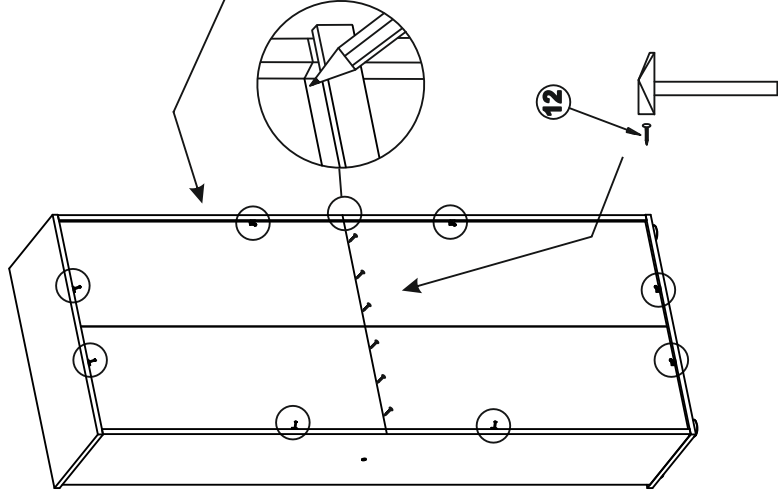
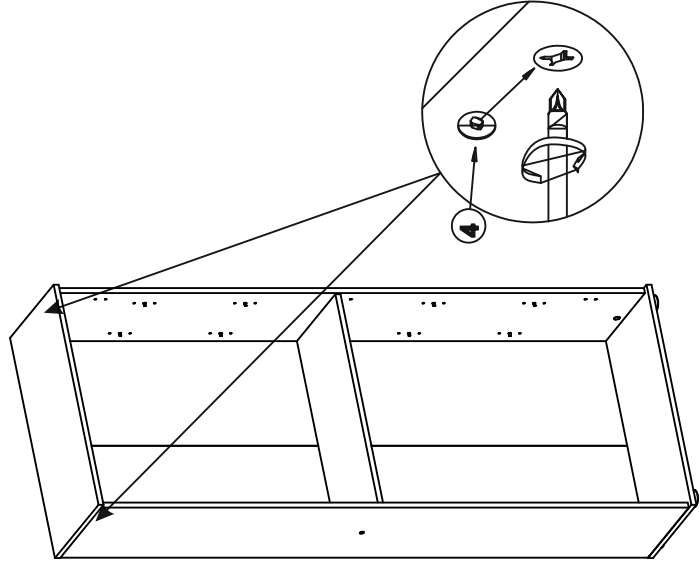
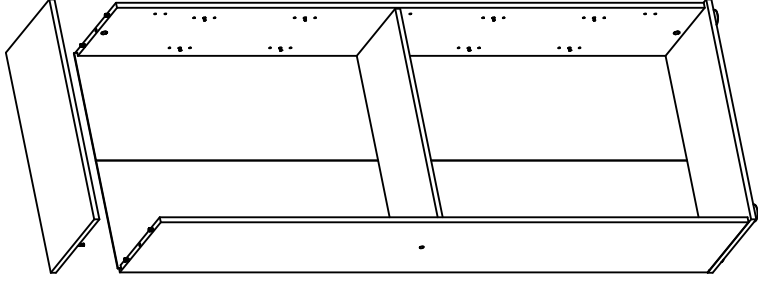
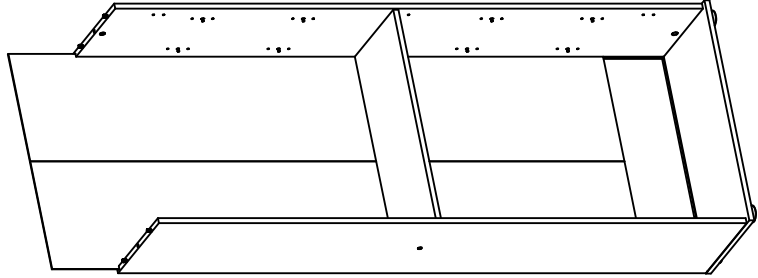
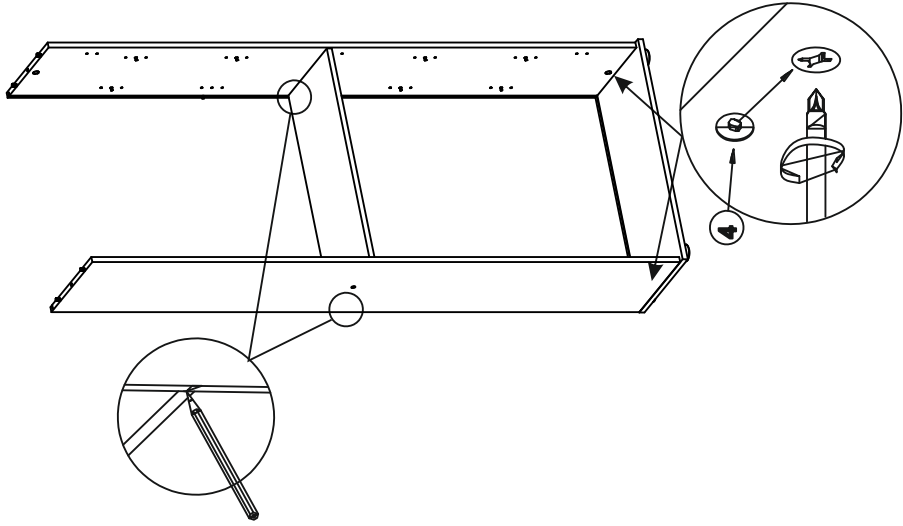

VETRA

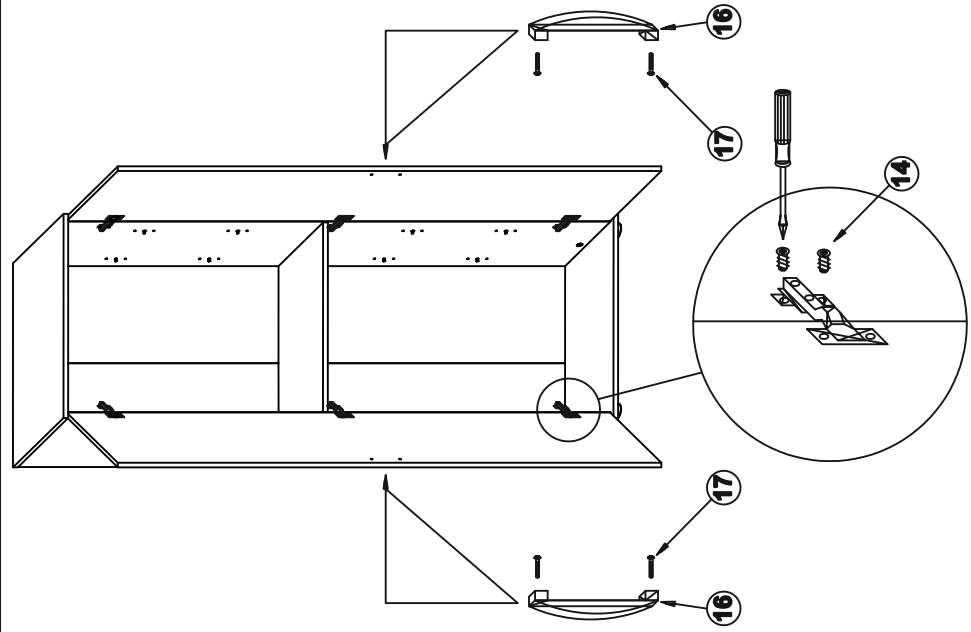

6-12

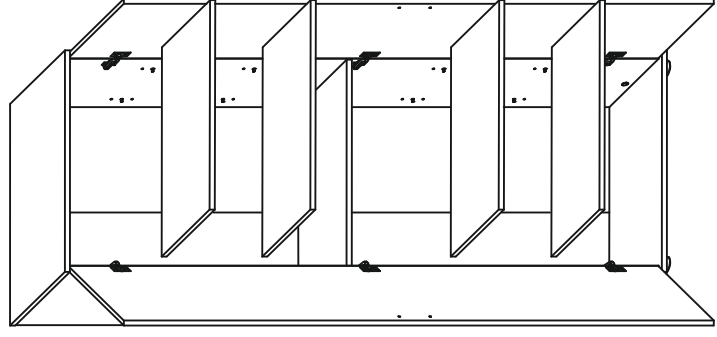

VETRA

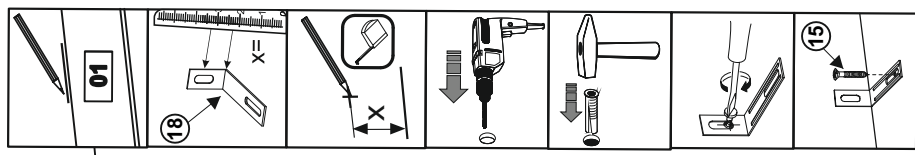
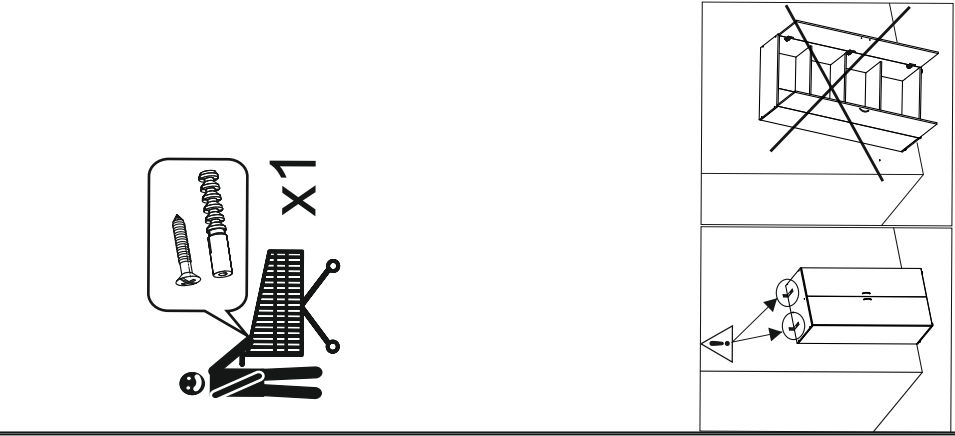

7-12

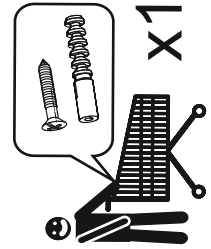

X1

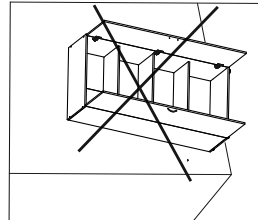
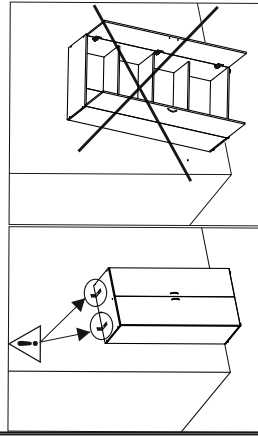



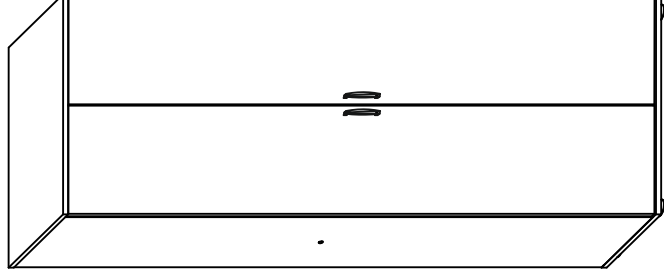
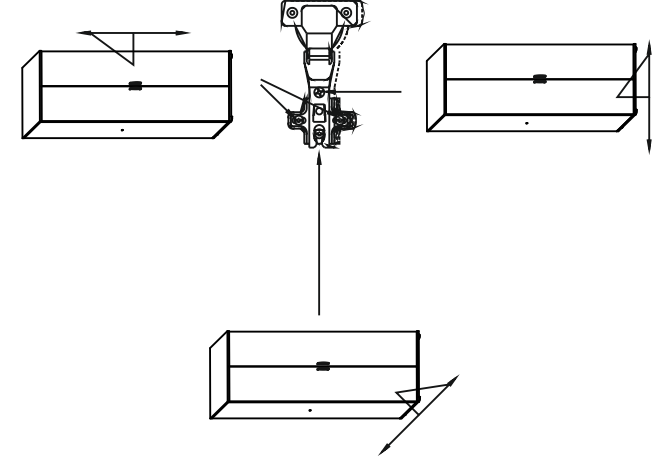
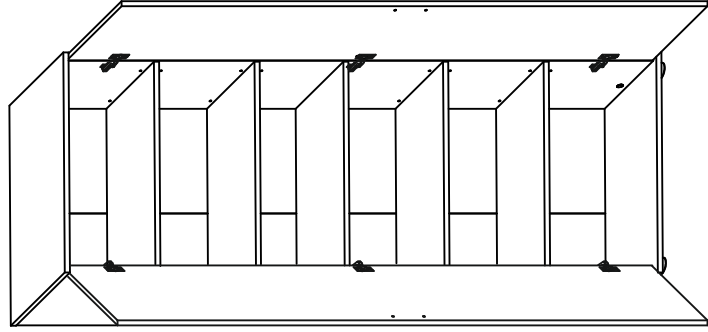



VETRA



11-12

VETRA

<p>Achtung  Möbel nie im befüllten Zustand verschieben. Sie können instabil werden, zusammenbrechen, umkippen oder andere Schäden können entstehen. Auch die Befüllung kann beschädigt werden.</p>	<p>Warning  Do not move your piece of furniture if loaded. Doing so, your piece of furniture could become unstable, collapse, tip over, and/or cause serious injuries.</p>	<p>Attention  Ne pas déplacer l'unité lorsqu'elle est chargée. Faire ainsi peut causer l'instabilité, l'effondrement ou le renversement du meuble et/ou des endommagements sérieux.</p>
<p>Achtung  Sofern Glasteile mitgeliefert werden, bitten wir Sie, diese während der Montage mit Vorsicht zu behandeln. Glas kann jederzeit brechen und somit Verletzungen verursachen. Schützen Sie deshalb unbedingt Ihre Augen und Hände mit im Handel erhältlicher Schutzkleidung.</p>	<p>Warning  Risk of breaking glass. If your piece of furniture consists of glass handle it carefully during assembling. Use eye and hand protection. Improper handling can result in cuts or lacerations.</p>	<p>Attention  Risque de bris de verre. Faites attentions lors de la manipulation du verre pendant l'assemblage. Utilisez des protections pour les yeux et les mains. Une mauvaise manipulation peut provoquer des coupures ou des lésérations.</p>

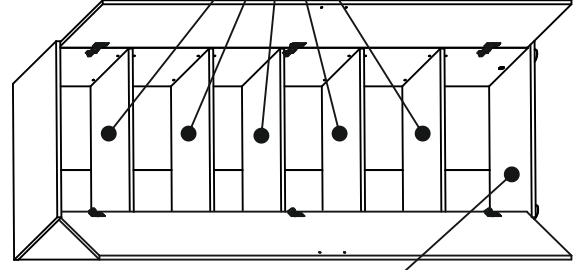

 10 kg max.

 5 kg max.

12-12