

Office Chair “ Jilli ”

Montage Anleitung / Notice de Montage / Assembling Instruction

ART.NR: 99 80 34 82

ORDER NO.: 17805



EAN-CODE: 40 10 340 83 48 27

DE Wichtige Montage – Tipps hier zum herunterladen:

SE Viktiga hämtningsförslag:

EN Important assembling suggestions download:

NO Viktige nedlastingsforslag:

FR Conseils de montage importants à télécharger ici:

FI Tärkeät kokoamisedotukset ladataan:

IT Download importanti suggerimenti di montaggio:

HU Fontos összeszerelési javaslatok letöltése:

CZ Důležité montážní tipy ke stažení zde:

EE Olulised kokkupanemisetepanekute allalaadimine:

PT Download de sugestões importantes de montagem:

SI Prenos pomembnih predlogov za sestavljanje:

ES Descarga de sugerencias de montaje importantes:

RS Преузимање важних предлога за састављање:

PL Pobieranie ważnych sugestii montażowych:

RU Важные предложения по сборке скачать:

NL Belangrijke montagesuggesties downloaden:

TR Önemli montaj önerileri indir:

SK Stiahnutie dôležitých návrhov na zostavenie:

GR Λήψη σημαντικών προτάσεων συναρμολόγησης:

BG Важни съвети за сглобяване, които да изтеглите от тук::

LT Svarbūs surinkimo pasiūlymai atsisiųsti:

RO Descărcare de sugestii importante de asamblare:

LV Svarīgu montāžas ieteikumu lejupielāde:

HR Preuzimanje važnih prijedloga za sastavljanje:

LU Wichtig Versammlungsvorschläge eroflueden:

DK Vigtige montage tips til at downloade:

ARB المهمة التجميع اقتراحات تنزيل:





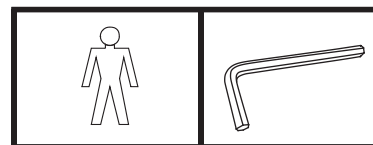

Office Chair “ Jilli ”

Montage Anleitung / Notice de Montage / Assembling Instruction

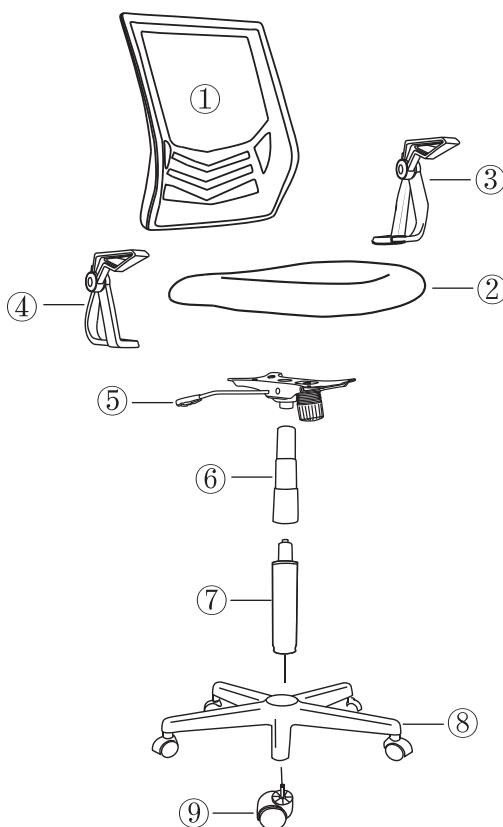

Für den Aufbau werden die hier abgebildeten Werkzeuge benötigt.
Avant le montage, se munir des outlis nécessaires.
For the assembly you need the tools shown above.



A	 M6*20mm	4
B	 M6*25mm	4
C	 M6*35mm	4

01

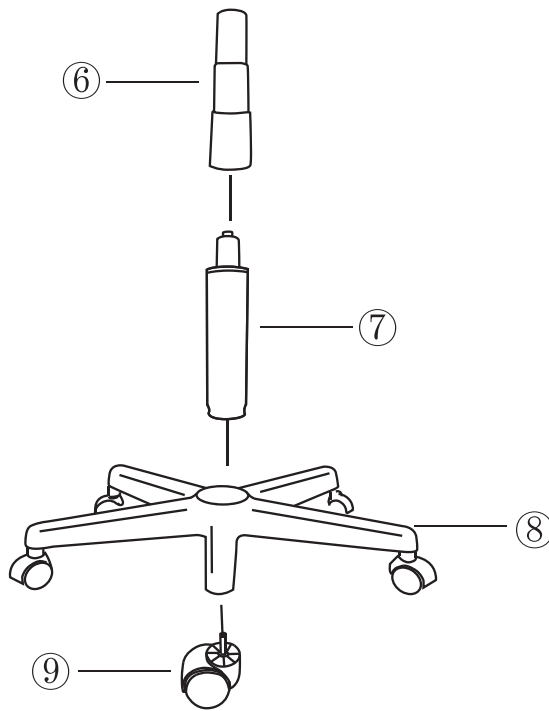

02

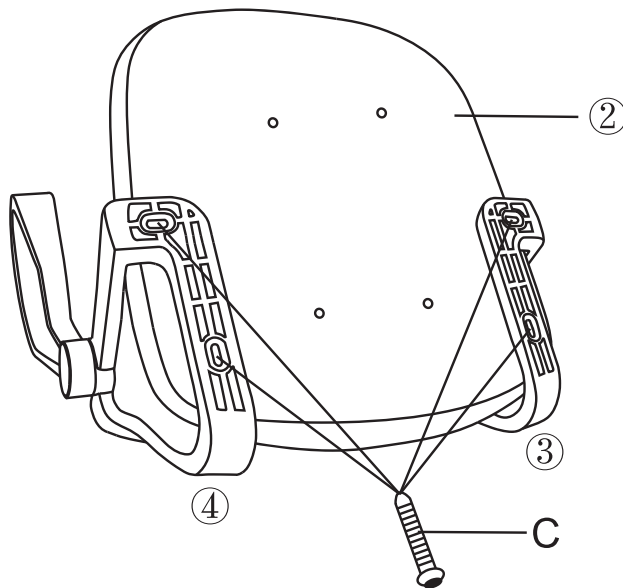

03

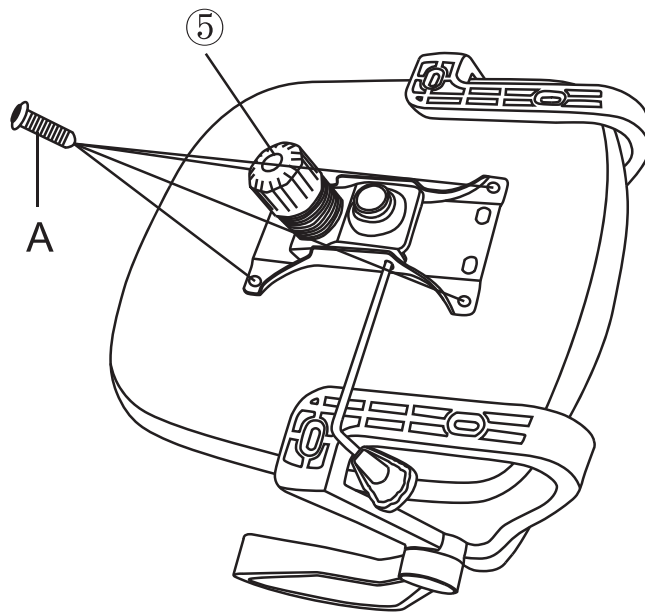

04

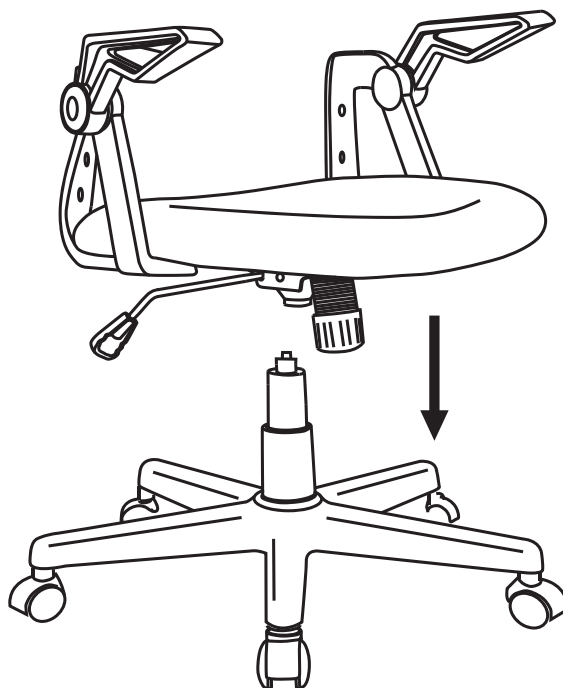

05

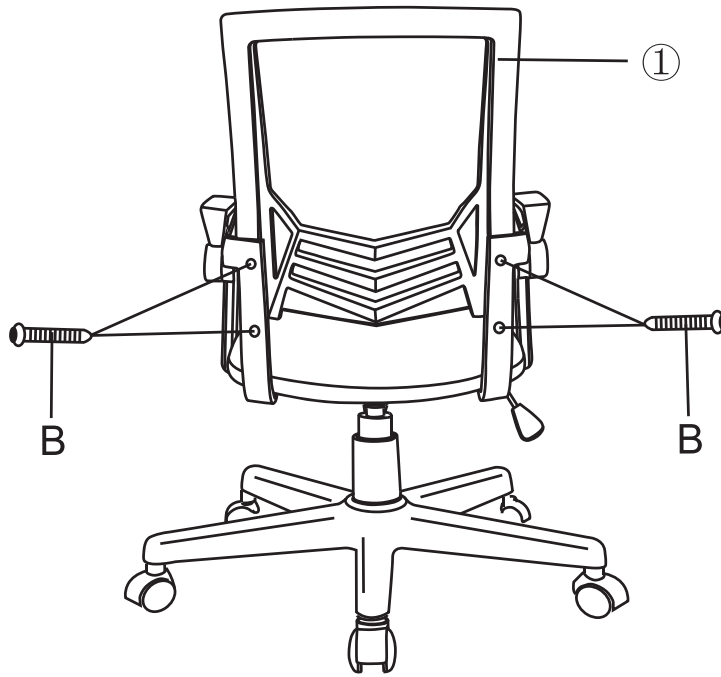

06

