

>>STICKS/3-33<<

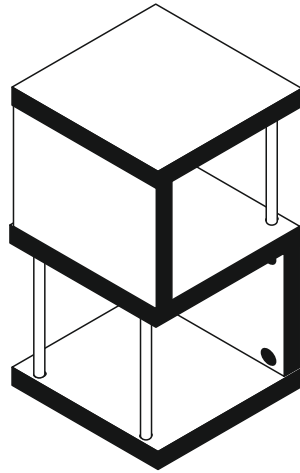

(D) Montageanleitung

(GB) Assembly instructions

(FR) Notice de montage

(TR) Montaj talimatı

(IT) Istruzioni di montaggio

(NL) Handleiding voor de montage

(RU) Инструкция по монтажу

(CZ) Montážní návod

(HU) Szerelési útmutató

(RO) Instrucțiuni de montaj

(PL) Instrukcja montażu

(SK) Návod na montáž

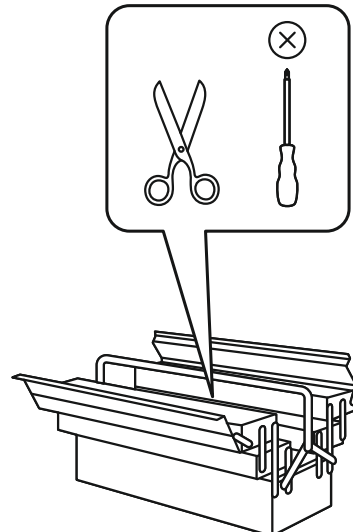
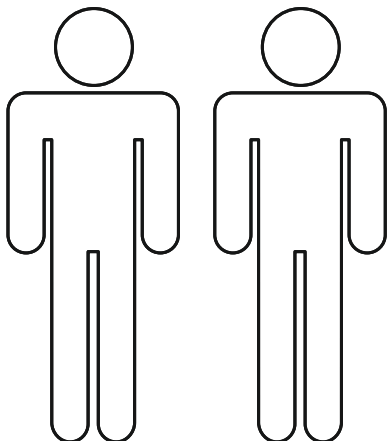

Service • Assistenza • Dienstverlening • Serwis Servis • Szerviz • Сервисная служба

Name • Nom • Nome • Naam • Nazwa • Jméno •
Názov • Név • Denumire • Isim • Название

Sticks/3-33

Nr. • No. • N° • Номер • Č • Sz

0510_00

Typ • Type • Tip • Típus • Тіро • Тип

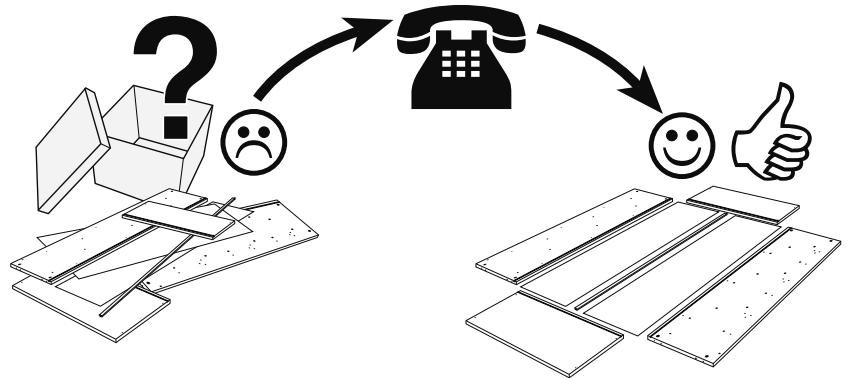
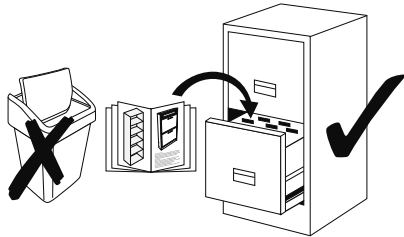

1-90		2-10		2-20		2-170	
4x	3,5x20	8x		8x		4x	
5-130							
1x							

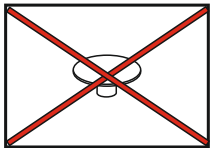
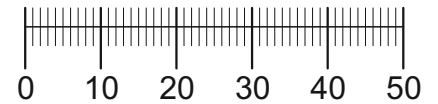

Artikel enthält keine
Abdeckkappen für
Excenter (Teil 2-10)!

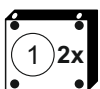

280 x 328

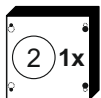

330 x 330

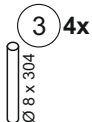

3 4x
Ø 8 x 304



330 x 330

